



Die flexiblen Verteilersysteme aus Kunststoff für Sanitär und Heizung

Operating Guide

SBK TwinCo 3000 distribution station



Siegfried Böhnisch
Maybachstraße 1
Tel +49(0)7942-944 926 0
info@sbk-neuenstein.de

Kunststofftechnik GmbH
D-74632 Neuenstein
Fax +49(0)7942-944 926 99
www.sbk-neuenstein.de

Table of contents

Technical data	3
SBK Tempus control overview	4
Thermal functionality SBK TwinCo 3000	5
Electric connection SBK Tempus control	6
Service and modes of operation	8
Outside temperature controlled flow temperature setting diagram	9
Constant flow temperature setting diagram	10
Function of the rotary knobs SBK Tempus control	11
Introduction	12
Mistake removal	14
Introduction security sheet	15
Appendix individual parts cultivation sentence	17
Appendix electric connection	17
Accessories	18
Notice	19

Technical Data

Suitable for floor surfaces to max. 1,200 l/h (approx. 28,800 kJ) with completely open throttle valve.

The connecting pipe is laid out for:

- Preliminary heat temperature heating system: min + 70°C
- Preliminary heat temperature floor: + 20°C to + 50°C
- Middle temperature difference: 6 ° to 8 °K and approx. 75 W/m²

Pump data:

- Wilo RS 25/6-3
- If 6 m nominal conveyor correspond with $Q = 0 \text{ m}^3 / \text{h}$
- Speed area 1.100 - 2.200, 1 / min
- 3 speed steps (achievement admission 46/67/93 W)
- Protective kind IP 42
- Sound pressure level recorder according to German Institute for Standardization 45635 to max. 34 dB (A)

Regulator data:

- Connection tension 230 V ~, 50 hertz
- Achievement admission 1.5 VA
- Protective kind IP 42
- Surroundings terms: – 20°C to + 50°C

Control valve:

About the control valve the required quantity of water (warm amount) is supplied to the floor circulation to reach the desired preliminary heat temperature.

Throttle valve:

The quantity of water which should flow in by the control valve onto the floor circle can be limited by the fine regulating spindle in the throttle valve. The volume stream from the secondary circle of the floor system in the primary circle of the heater arrangement flows back and becomes braked. Thereby becomes the raised assembly line speed which arises from the addition of the primary pump pressure and the secondary pump pressure, reduces again.

Security temperature limiter:

The arrangement is equipped with a security temperature limiter which switches off the complete arrangement at a floor preliminary heat temperature > 60°C.

Pump:

The secondary pump becomes with the modes of operation

- Steady preliminary heat temperature
 - Preliminary heat temperature as a leadership size
- when long term runners pursued. A combination with the control distributor with integrated pump switch off modul (option kind no.:6.013.048.030) allows a regulated disconnection of the control and therefore also of the pump and is to be advised for the lengthening of the life span of the pump and the energy conservation.

To the avoidance of hydraulic problems we recommend the additional installation of hydraulic points.

SBK TEMPUS CONTROL

Overview

Tempus is a modern digital controller which combines the simple operation known from normal analogue devices with the precision and wide-ranging functions of a digital device.

- Tempus controls the flow temperature based on the outside temperature with automatic limitation of the maximum flow temperature.
- Tempus can also be used as a fixed value controller, i.e. the set flow temperature is adhered to precisely (standard model).
- Tempus controls valves to set the afflux. The valves open and close slowly (approx. 5 minutes). The controller is optimal for use with underfloor heating.

Integrated safety functions

In addition, Tempus has numerous integrated safety functions to protect the system.

- **Safety temperature limitation**
Every heating system should be secured by a double safety function, therefore a safety thermostat (safety temperature limiter) has also been integrated in addition to the safety functions of the controller to limit the maximum performance of the heating system.
- **Anti-block logic for the pump**
When the system is controlled by the outside temperature or boiler temperature, the pump switches off as soon as the outside temperature is approximately 1 °C higher than the set room temperature (control knob B). The pump is switched back on again as soon as the outside temperature drops approximately 2 °C below the set room temperature.
If the outside temperature is higher than the room temperature for a longer period of time e.g. in the summer, the pump is switched off and only switched on again for a short period at fixed intervals to prevent the pump from getting stuck.
If control knob C is turned to OFF, this function is activated automatically.
- **Anti-blocking logic for valve**
The valve is also switched on for a short period of time in the same way as the pump is in order to prevent it from getting stuck.
- **Failure of a sensor**
If the outside sensor is missing or has failed, the system automatically switches into the “constant flow temperature” mode.

If the flow sensor is missing or has failed, the valve is controlled with the opening half open and therefore a basic heating is established for safety reasons.

Thermal function of the SBK TwinCo 3000

The well know principle of heating circuit distribution for underfloor heating made up of flow distributor and return distributor is supplemented by a control valve and a pump.

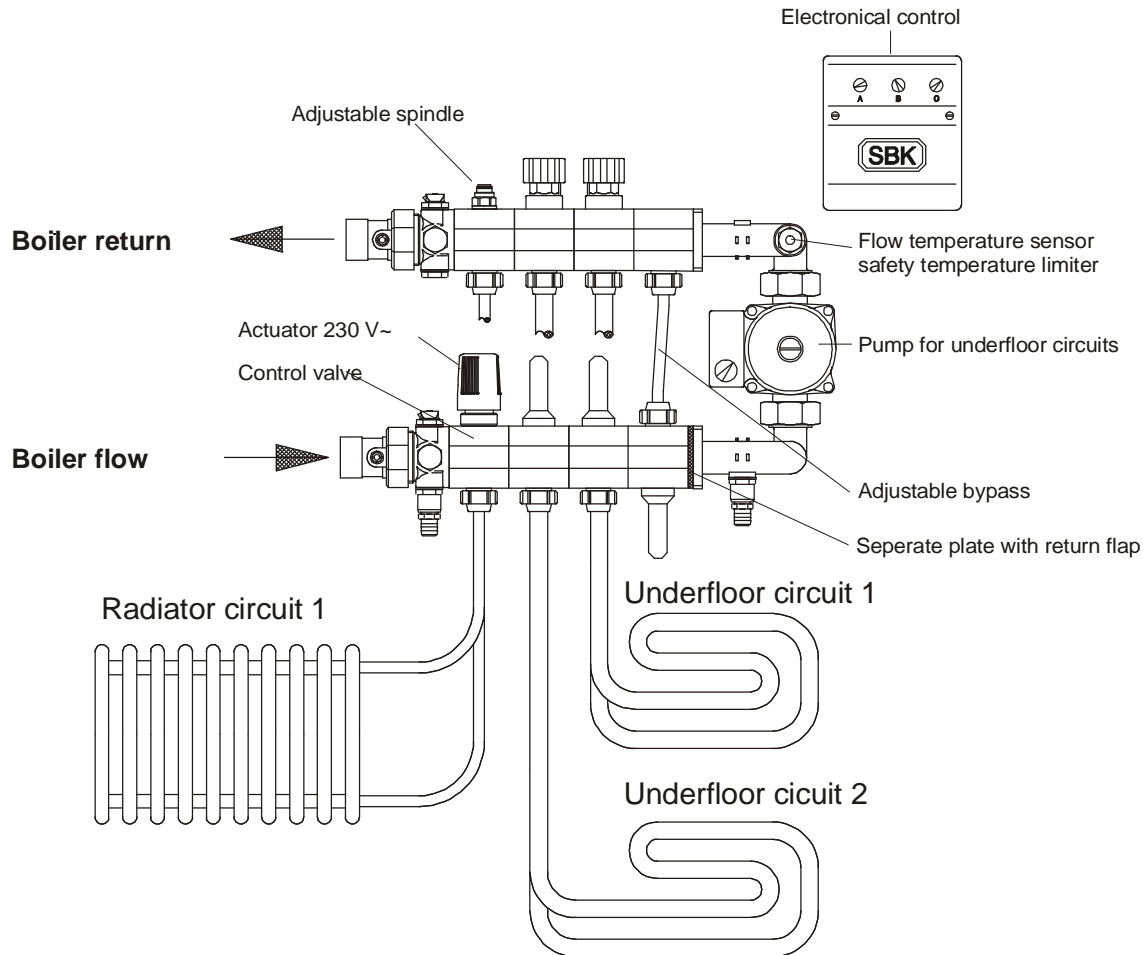

Fig. 1: TwinCo 3000

Warm heating water flows from the flow distributor through the underfloor heating pipes – during which it cools down – and then into the return flow distributor. Here it is mixed with the warm heating water from the heat generator (boiler, gas circulator) and then pressed back into the flow distributor by a pump. This pump also serves as the transport pump of the water in the underfloor heating circuit. The volume of heating water coming from the heat generator is controlled by a valve. However, in this particular case, the boiler flow is connected to the underfloor distributor return flow and the boiler return flow is connected to the underfloor distributor flow. The control valve is positioned in front of the supply line of the underfloor return distributor beam (see diagram).

SBK Tempus controls the pump and the valve which influences the flow of heating water into the return flow distributor. If the required flow temperature has not been reached, the valve is opened. If the required flow temperature is exceeded, the valve is closed. The valve opens and closes slowly in small steps.

The required flow temperature is set either by selecting the flow temperature using control knob "C" (see page 4) or by calculation using the current outside or boiler flow temperature.

Installation and connection

The system is installed and connected according to Fig. 2. The electrical connection must be made by a qualified electrician and he will also be responsible for ensuring that the safety regulations are adhered to as required by the current stand of technology.

The outside sensor (special accessories) should be fitted in a protected place facing north. The cross-section of the cable connecting the sensor to the controller is not important.

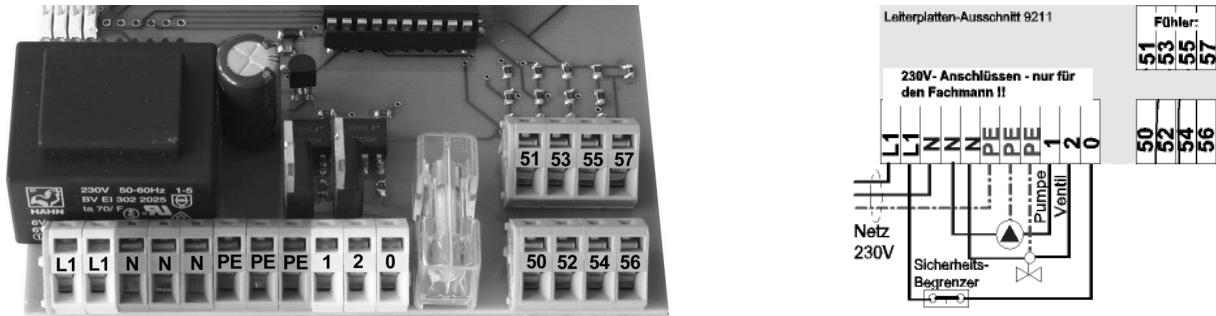

Fig. 2: Connecting diagram

Terminal allocation

Voltage supply 230 V	L1, N, PE
Safety temperature limiter	L1,0
Pump	N,1,PE
Actuator for control valve	N,2
Flow sensor underfloor heating circuit	50,51

Outside temperature controlled flow temperature

Voltage supply 230 V	L1, N, PE
Safety temperature limiter	L1,0
Pump	N,1,PE
Actuator for control valve	N,2
Flow sensor underfloor heating circuit	50,51
Outside temperature sensor (optional)	52,53

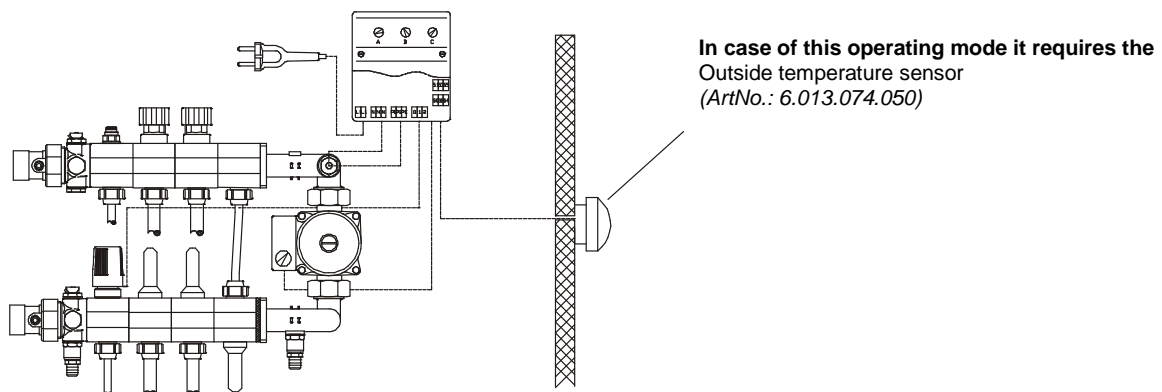

Fig. 3 TwinCo 3000 with outside temperature sensor

Boiler controlled flow temperature

Voltage supply 230 V
 Safety temperature limiter
 Pump
 Actuator for control valve
 Flow sensor underfloor heating circuit
 Flow sensor for boiler temperature (optional)
 Bridge between

L1, N, PE
 L1,0
 N,1,PE
 N,2
 50,51
 52,53
 54, 55

In case of this operating mode it requires the

Bypass
 (OrderNo. 6.013.074.070)

supply sensor
 (Order No.: 6.013.074.051)

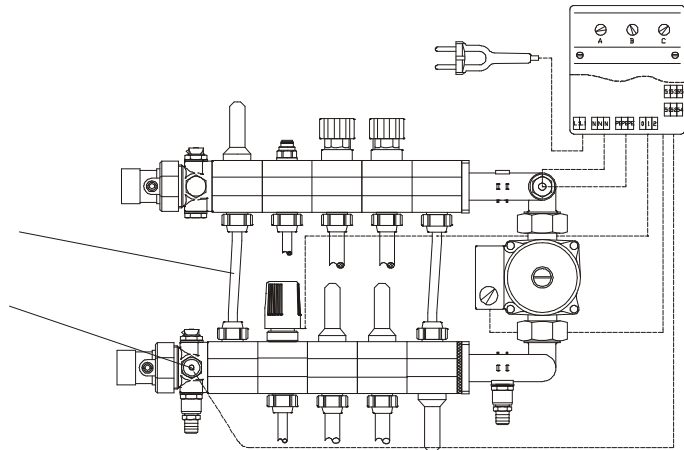

Fig. 4: TwinCo 3000 with supply sensor

Operation and operating modes

The controller SBK Tempus can work in three different modes

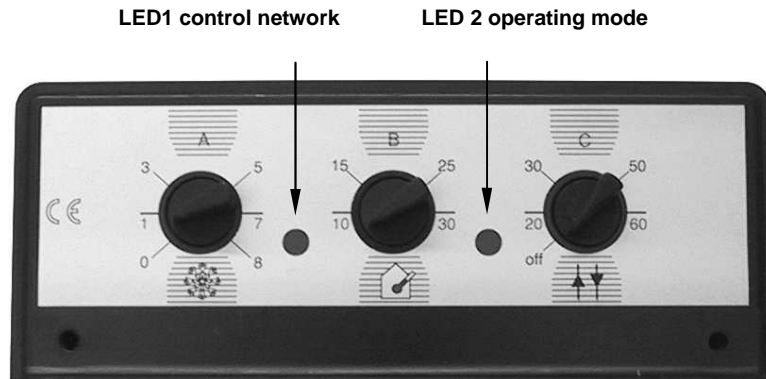

Fig. 5: Operating panel of the control unit

Constant flow temperature

If it controls an additional heating system, in the bathroom or conservatory, the floor should always have a constant temperature. An outside sensor may not be connected for this operating mode

Control knob A has no function (**do not turn all the way to the right**)

Control knob B has no function (**do not turn all the way to the right**)

Control knob C is used to set the required flow temperature

Climate controlled or outside temperature controlled flow temperature

The heating curve is set in accordance with the planning documents. In compliance with DIN 4701, the planning data is always based on a room temperature of 20°C at an outside temperature of -15°C.

Control knob A is used to set the calculated flow temperature (diagram 1 page 7)

Control knob B is used to set the required room temperature

Control knob C is used to set the maximum admissible flow temperature.

ATTENTION: The set temperature must be higher than the temperature set at control knob A.

Boiler controlled flow temperature

The heating curve is set in accordance with the planning documentation. The data is always based on a room temperature of 20°C at a boiler flow temperature of 70°C.

Control knob A is used to set the calculated flow temperature (diagram 2 page 8)

Control knob B is used to set the required room temperature

Control knob C is used to set the maximum admissible flow temperature.

ATTENTION: The set temperature must be higher than the temperature set at control knob A.

Special operating mode

Pump test mode: Control knob A must be turned all the way to the right, the pump is switched on, the valve is switched off.

Valve test run: Control knob C must be turned all the way to the right. Both the pump and the valve are switched on.

Switching off pump: Control knob C must be turned all the way to the left, the pump is switched off (summer mode: function anti-block logic for pump and valve is active).

Settings of control knob A for outside temperature controlled operating mode

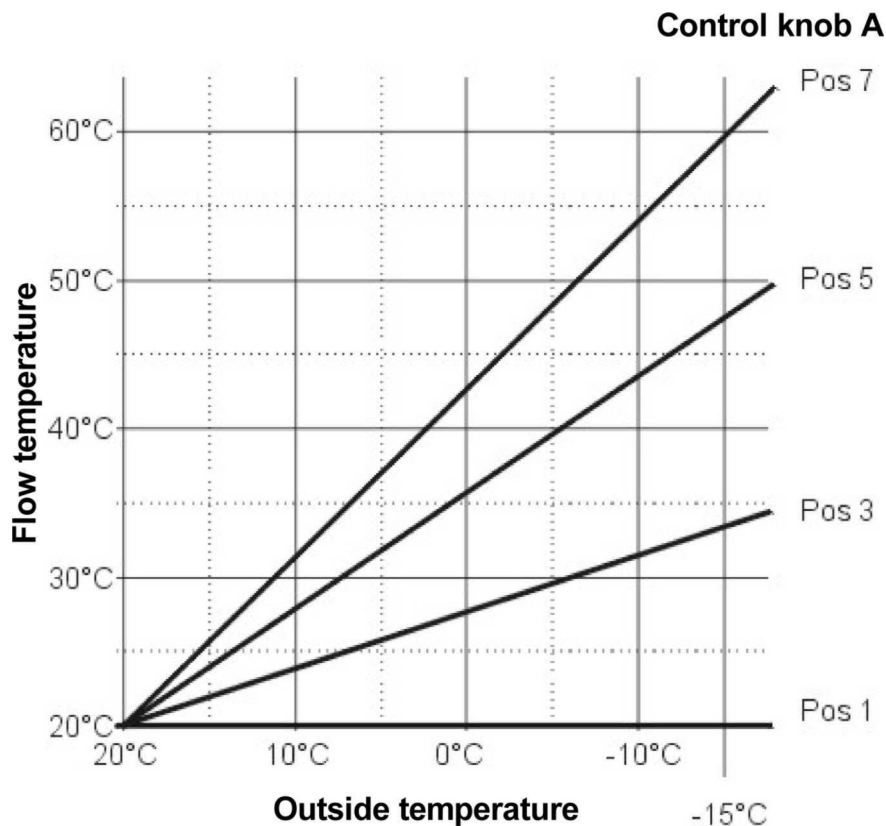

Fig. 6: Diagram 1 heating curve for operation controlled by outside temperature

The heating curve is set in accordance with the planning documentation. According to DIN 4701 the planning data is always based on a room temperature of 20°C at an outside temperature of -15°C.

Control knob A in position 1

Calculated flow temperature 20°C at an outside temperature of -15°C and 20°C room temperature

Control knob A in position 3

Calculated flow temperature 33°C at an outside temperature of -15°C and 20°C room temperature

Control knob A in position 5

Calculated flow temperature 48°C at an outside temperature of -15°C and 20°C room temperature

Control knob A in position 7

Calculated flow temperature 60°C at an outside temperature of -15°C and 20°C room temperature.

Settings of control knob A for boiler temperature controlled operating mode

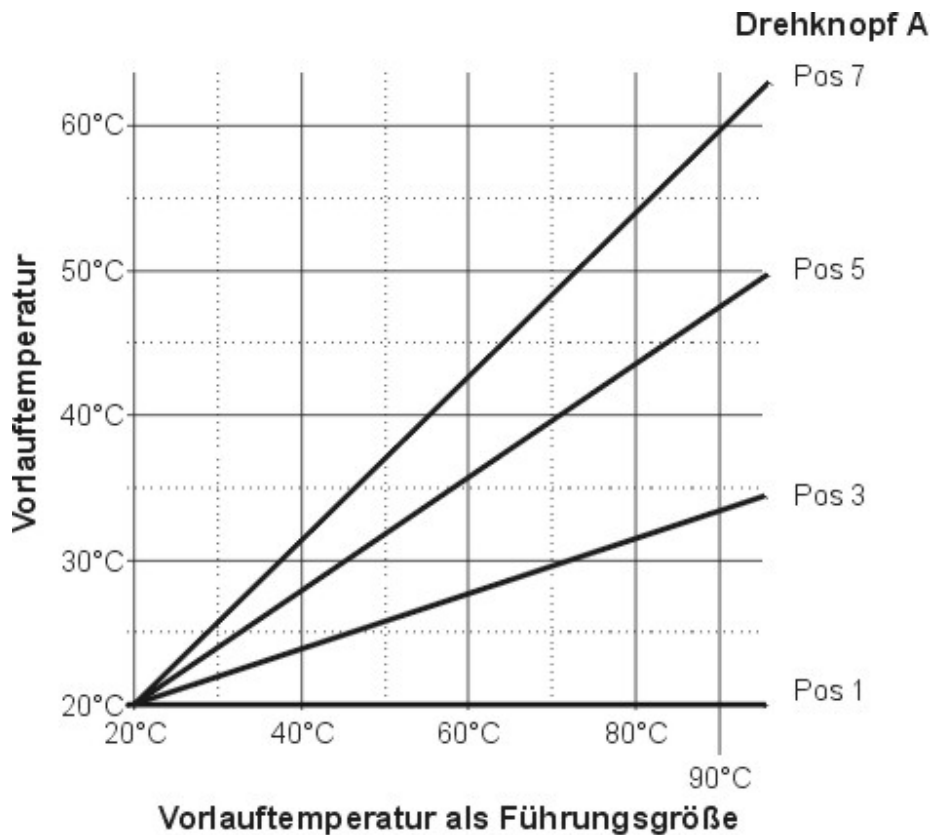

Fig. 7: Diagram 2 heating curve for operation controlled by boiler flow temperature

The heating curve is set in accordance with the planning documentation. The data is always based on a room temperature of 20°C at a boiler flow temperature of 70°C.

Control knob A in position 1

Calculated flow temperature 20°C at an boiler flow temperature of 70 °C and 20°C room temperature

Control knob A in position 3

Calculated flow temperature 29°C at a boiler flow temperature of 70°C and 20 °C room temperature

Control knob A in position 5

Calculated flow temperature 38°C at a boiler flow temperature of 70°C and 20 °C room temperature

Control knob A in position 7

Calculated flow temperature 47°C at a boiler flow temperature of 70°C and 20 °C room temperature.

Function of control knobs

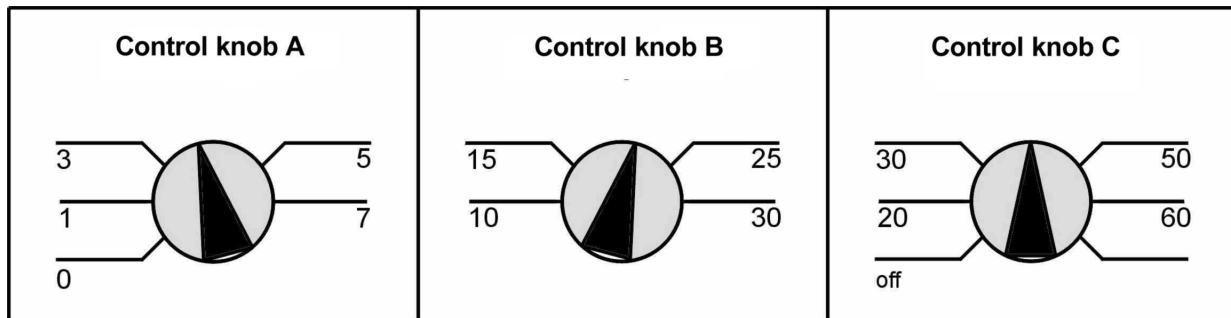

Operating mode based on climate or outside temperature controlled		
<p>This control knob is used to set the heating circuit flow temperature which is to be realized by the control system according to the design of the heating system (DIN 4701)</p> <p>Together with control knob B is it is used to calculate the heating curve</p> <p>Special function Turn the control knob all the way to the right, pump starts up, valve remains closed</p>	<p>This control knob is used to specify which required set value temperature is to be realized.</p> <p>It is used to calculate the heating curve together with control knob A.</p> <p>Special function: Turn the control knob all the way to the right, Outside temperature sensor/ supply sensor has no function</p>	<p>This control knob is used to set the maximum permissible flow temperature for the heating circuits.</p> <p>Attention: The set temperature must be higher than the temperature set using control knob A</p> <p>Special function: Turn control knob all the way to the right. Pump is activated. Valve is opened. Turn the control knob all the way to the left. Pump is switched off</p>
Operating mode constant flow temperature		
<p>Control knob does not have a function</p> <p>Special function Turn the control knob all the way to the right, pump starts up, valve remains closed</p>	<p>Control knob does not have a function</p> <p>Special function: Turn the control knob all the way to the right, Outside temperature sensor/ supply sensor has no function</p>	<p>Use this control knob to set the maximum permissible flow temperature for the heating circuits.</p> <p>Special function: Turn the control knob all the way to the right. Pump starts up, valve is opened. Turn the control knob all the way to the left. Pump is switched off.</p>
<p>Attention: Never turn all three control knobs all the way to the right at the same time whilst the system is operational, as otherwise an internal test function is inadvertently activated which can lead to faults with the control unit.</p>		

Attention safety information:
(Please fix this sheet in a clearly visible place on the station)

Before starting up the TwinCo 3000 distributor station, the system must be filled with water and completely de-aired to protect the pump.

The electrical connection must be made by a qualified electrician who will ensure that the safety regulations are be adhered to.

Started up by:

Company: _____

Name: _____

Signature: _____

Date: _____

Please enter the position of the control knobs here when starting up the system.

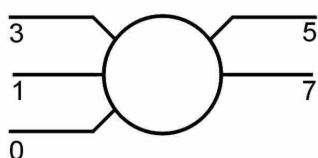
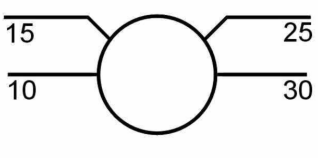
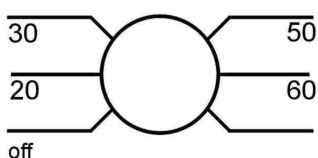
Control knob A	Control knob B	Control knob C
		

Calibration for sensor BEC-UNISENS1

Outside temperature sensor, supply sensor for SBK TwinCo 3000 distribution station

Technical data

IP 65

Temperature range-40 °C up to 70 °C

Temp °C	kΩ	Ω
-20	229,31	229310,00
- 15	169,02	169020,00
-10	125,85	12850,00
- 5	94,15	94153,00
0	71,12	71126,00
5	54,23	54237,00
10	41,71	41719,00
15	32,40	32409,00
20	25,36	25367,00
25	20,00	20000,00 <i>i</i>
30	15,88	15884,00
35	12,65	12654,00

Temp °C	kΩ	Ω
40	10,14	10148,00
45	8,20	8205,30
50	6,67	6672,60
55	5,44	5448,60
60	4,47	4473,90
65	3,69	3691,80
70	3,06	3060,90
75	2,55	2551,00
80	2,13	2135,50
85	1,79	1798,60
90	1,52	1521,40
95	1,29	1290,50
100	1,09	1098,80

Appendix SBK TwinCo 3000 individual parts

Pos.	Name	Quant.
1	SBK throttle valve	1
2	Adjust spindle	1
3	Seperating plate with return valve	1
4	Mains plug 230 V~	1
5	SBK HKV 2000 flow segment	1
6	Connectng arm for pump	2
7	Electronic control	1
8	Immersion sleeve with flow temperatur sensor and safety temperature limiter	1
9	Flat packing	2
10	Union nut	2
11	Pump	1
12	SBK HKV 3000 return flow segment DFM 177	1
13	Locking cap 3/4"	2
14	SBK controle valve	1
15	SBK actuator 230V~	1
16	Bypasspipe 16x2 MSV-pipe With connections	1
17	Filling and drain valve	1

